

# Rack System



**Up to 40%**  
GREATER STORAGE CAPACITY



# PEGASUS MEDICAL

**Pegasus Medical** is the partner of leading healthcare organizations and hospitals in 5 continents.

Our clients recommend our products and solutions since we greatly **simplify healthcare materials** management with flexible and scalable solutions.

We provide **significant cost savings** and stand behind our methodology with **unmatched expertise and support.**

## AMONG OUR CUSTOMERS:

### PeaceHealth



4 Hospitals in Kanban, ranging from 100-500 racks

### US Naval Ships



USNS Mercy & Comfort, approximately 900 racks

### US Naval Hospitals



10 Facilities in Kanban, 2650 total racks

### Veterans Administration



Kanban and High-Density Storage, over 30 facilities with 7,000+ racks

### Penn Presbyterian Med Ctr



250 racks. Kanban & Color Coding

### NYC Health+Hospitals



4 Hospitals, Kanban, 2200+ racks.

# UNIQUE FEATURES

Clinicians need to quickly and easily locate supplies for better patient care and efficient operations.

Studies show that nurses spend at least 5-20% of their time on retrieving supplies.

Well-designed and implemented supply storage and inventory management systems can **dramatically decrease time** spent by nurses on retrieving supplies.

Utilize floor space

Simple color-coding technology to locate items

Ergonomic design (tilted + angled baskets)

Ergonomic labeling and marking

Fit-to-space Kanban solution



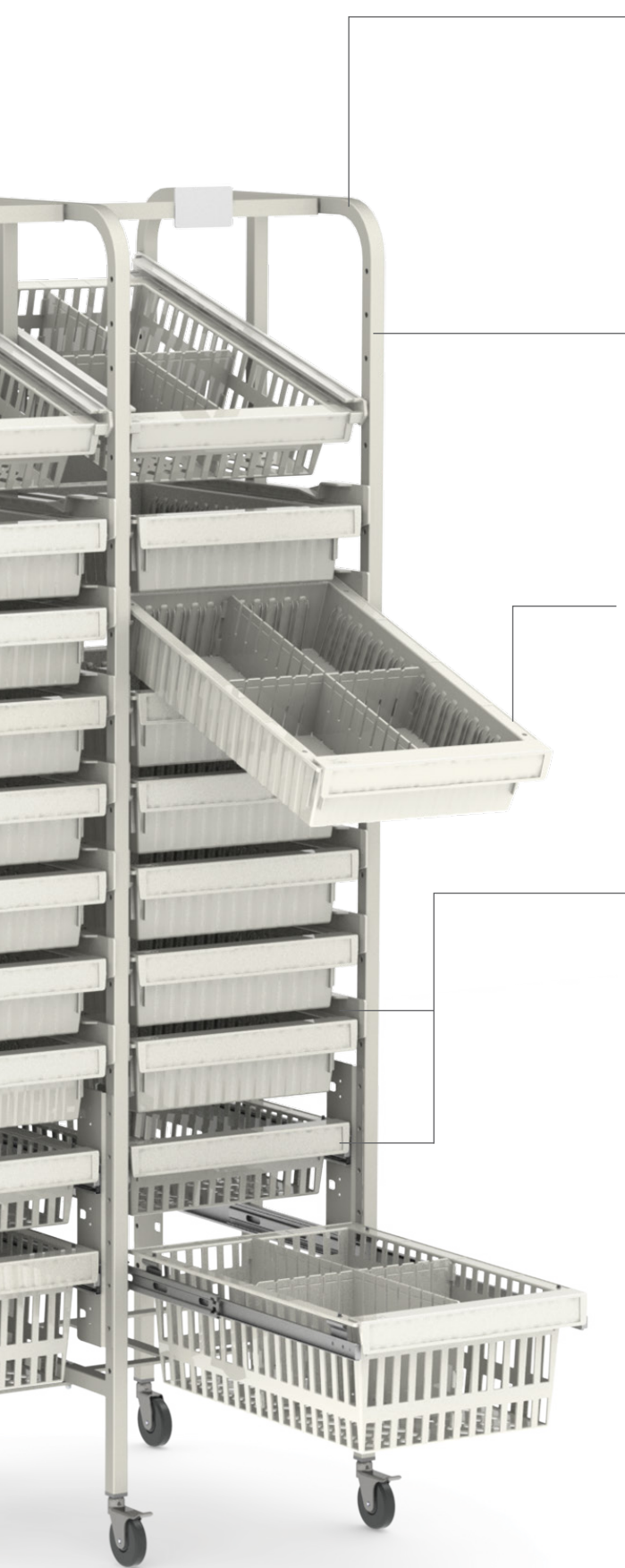

## HYGIENIC

- Easy-to-clean smooth surfaces
- Pull out modules for easy cleaning

## DURABLE

- 40kg load capacity
- Telescopic rails for heavier loads
- Durable coating (zinc plated + powder coating)

## ERGONOMIC

- Baskets can be permanently angled or stored horizontally and tilted while in use

## MODULAR

- Tool-free repositioning of basket configuration
- Flexible divider system
- 3 different basket / tray depths (5, 10 and 20cm)

# WORKING SPACE UTILIZATION



Gaps or dead air spaces are required between shelves in order to enable access to the products at the back of the shelves

Products on top levels can not be easily accessed

1 SQM/SQF of flat shelving foot print



200 cm

240 cm

Dead spaces



Up to 40% greater storage capacity per sqt/sqm

Baskets are fully retractable - hence, no gaps are needed between the baskets, no space is wasted and easy access to supplies at the back of the basket is assured

Clear line of sight + easy and ergonomic access to all baskets at the higher levels

Can be decreased into 0.65 SQM/SQF footprint of dense storage

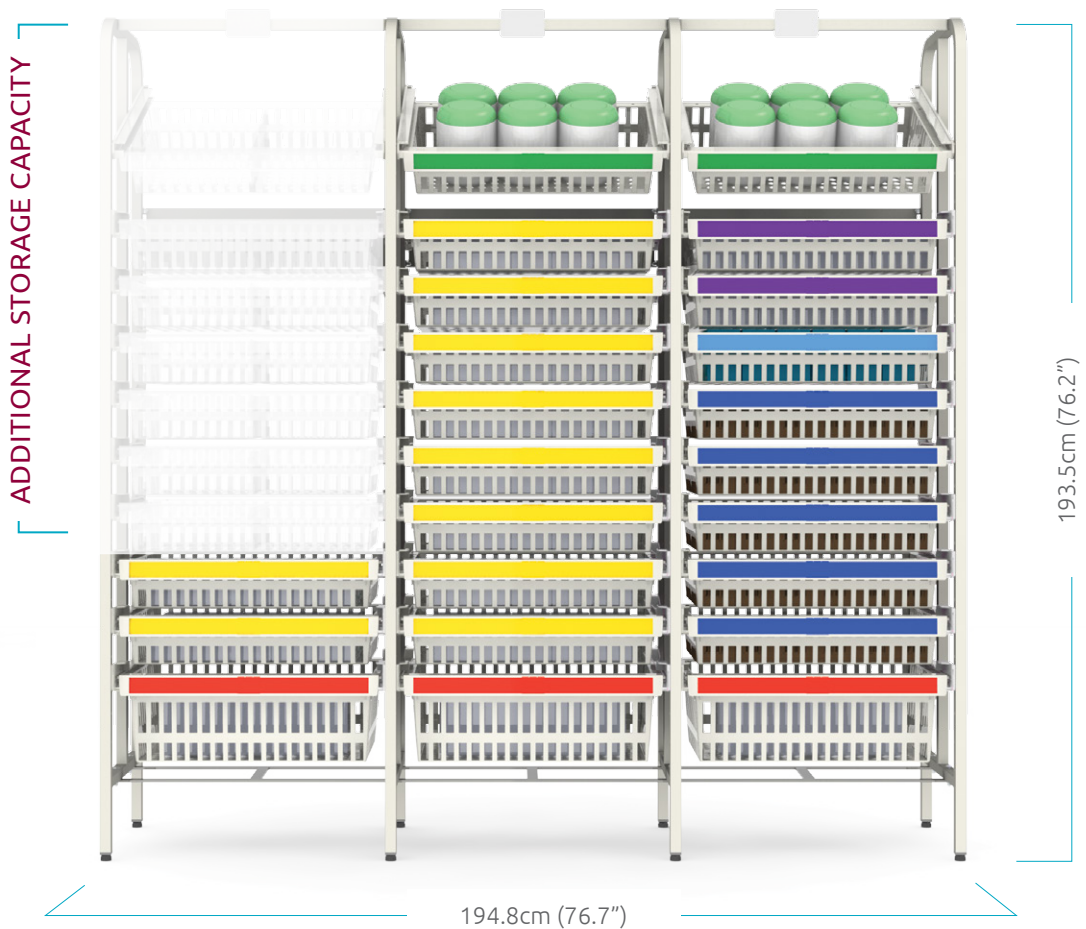

# ORGANIZED STORAGE

CLINICIANS NEED TO QUICKLY AND EASILY LOCATE SUPPLIES TO PROVIDE FASTER, BETTER PATIENT CARE AND EFFICIENT OPERATION

By placing supplies in appropriate categories and applying unique colors to each category, the clinicians are provided greater visibility.

Pegasus has developed new ergonomic basket handles with interchangeable colored strips, enabling clinicians to quickly locate supplies using colored group categories:

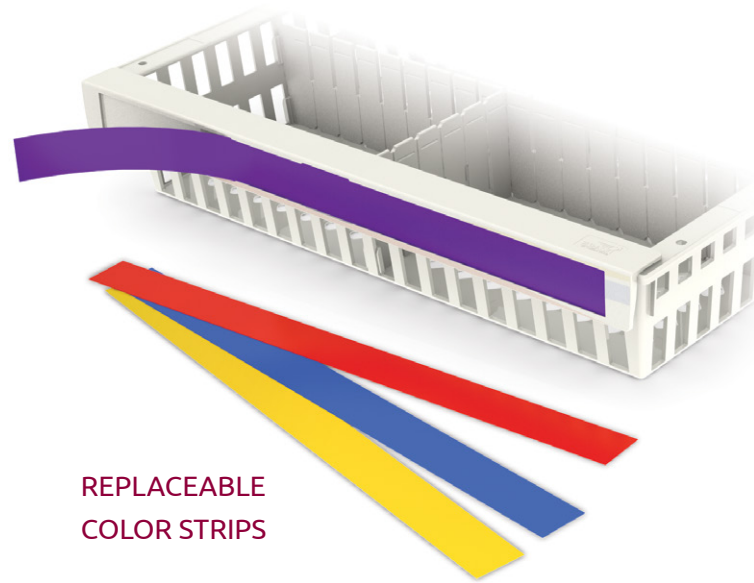



CATEGORY COLORS & RACK LOCATOR

<b>IV/NEEDLES</b>	<b>GASTRO/GI</b>	<b>ORTHOPEDICS</b>
<b>HYGIENE</b>	<b>LABORATORY</b>	<b>WOUND CARE-DRESSING</b>
<b>UROLOGY</b>	<b>MISCELLANEOUS</b>	<b>CARDIO-VASCULAR</b>
<b>PROCEDURE</b>	<b>RESPIRATORY</b>	

\*Over 20 colors to choose from



# RACK DIMENSIONS

INCREASED EFFICIENCY IN ORGANIZING SUPPLIES is achieved by using Pegasus dense storage racks in two orientations (E, U), and multiple basket depths configurations

U Type

E Type

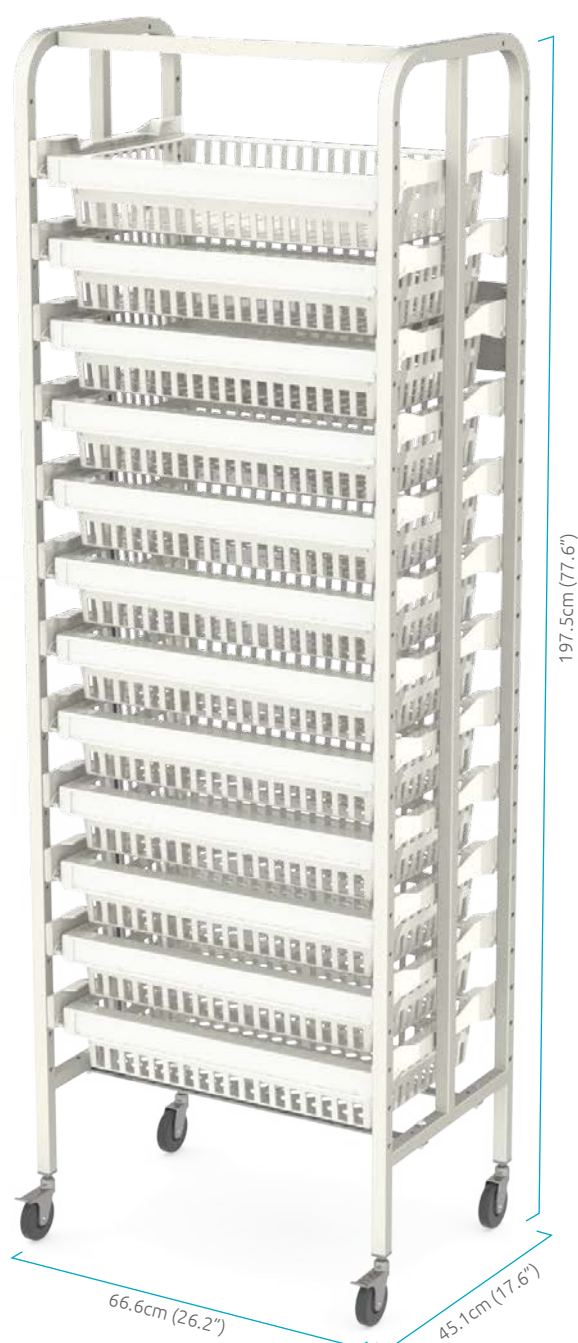
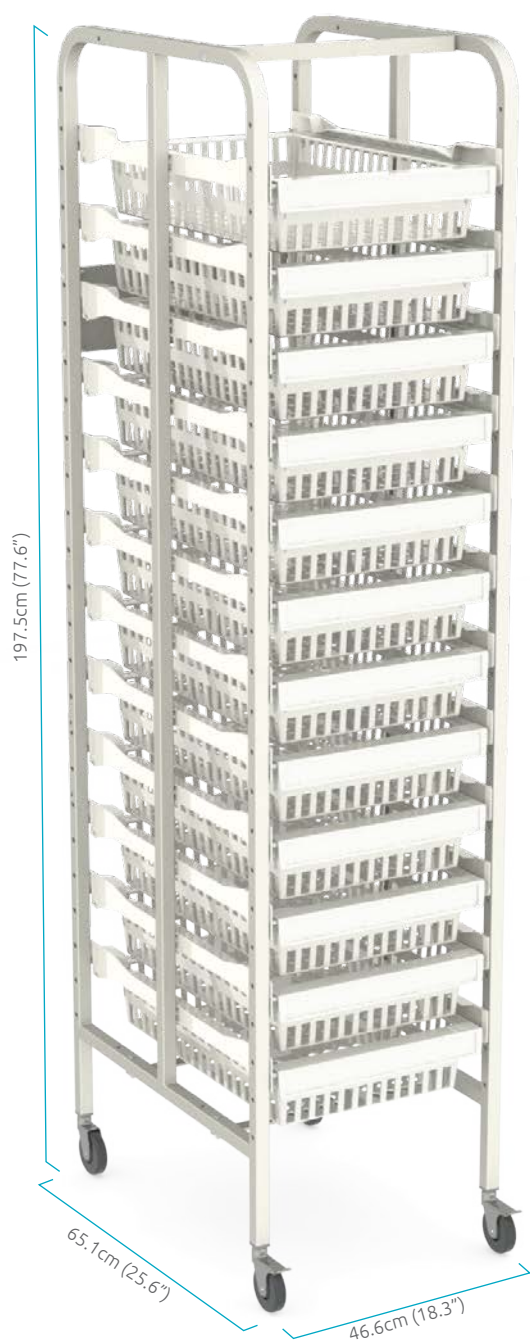

U type basket orientation:  
40cm (15.7") front and  
60cm (23.6") deep

E type basket orientation:  
60cm (23.6") front and  
40cm (15.7") deep

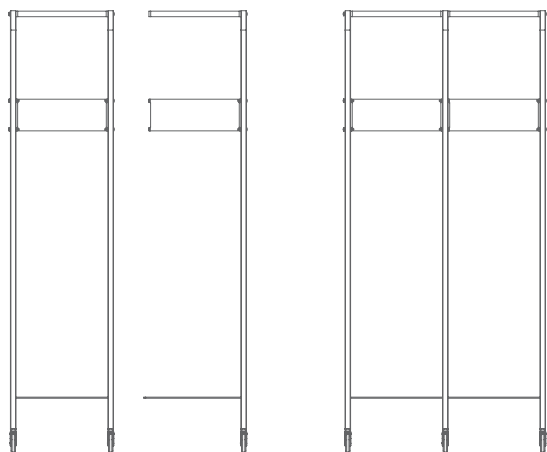

STARTER

ADD-ON

PRODUCT DESCRIPTION	DEPTH cm / inch	WIDTH cm / inch
STARTER RACK - U	65.1cm (25.6")	46.6cm (18.3")
ADD-ON RACK - U	65.1cm (25.6")	44.1cm (17.4")
STARTER RACK - E	45.1cm (17.6")	66.6cm (26.2")
ADD-ON RACK - E	45.1cm (17.6")	64.1cm (25.3")

# SYSTEM COMPONENTS

## RAILS

### ANGLED RAILS

Fixed rails for top access

### HORIZONTAL/TILT RAILS

Baskets can be pulled and tilted.  
(up to 5 kg)

Optional "click-in" wheels for  
smoother basket sliding (5-10kg)

### TELESCOPIC RAILS

To be used with baskets  
heavier than 10kg

100% extension



\* For safety reason it is not allowed to load more than 10 kg in baskets placed on telescopic slides at upper levels (above 140cm)

## BULK ITEMS

Bulk items can be stored on wire shelving in  
combination with dense storage baskets

### DOUBLE U WIRE SHELF

65cm (25.6") / 85.5cm (33.7")

### TRIPLE U WIRE SHELF

65cm (25.6") / 129.7cm (51.5")

### DOUBLE E WIRE SHELF

45cm (17.7") / 125.6+cm (49.4")

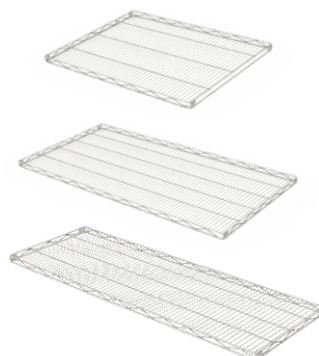

# TRAYS AND BASKETS



## ABS CREAM COLOR



10cm TRAY - T104060ND  
(No Dividers)  
LID - L4060



5cm TRAY - T054060



10cm TRAY - T104060



20cm TRAY - T204060



5cm TRAY - T053040



10cm BASKET - B103040



10cm BASKET - B104060



20cm BASKET - B204060

## POLYCARBONATE CLEAR COLOR



5cm TRAY - T054060PC

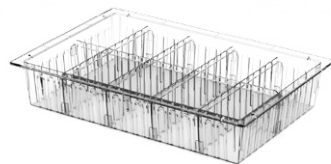

10cm TRAY - T104060PC



20cm TRAY - T204060C



20cm BASKET - B204060PC

## ANTIMICROBIAL MODULES

Proven to reduce the levels of bacteria on the module surface by up to 99% within 24 hours.



5cm TRAY - T054060-AM-G



10cm TRAY - T104060-AM-G



20cm TRAY - T204060-AM-G



\*LID - L4060-AM-G

## HIGH RESISTANCE

Used for cleaning application in central sterilization facilities



10cm TRAY - T103040-HR



10cm TRAY - T104060-ND-HR



20cm TRAY - T204060-HR

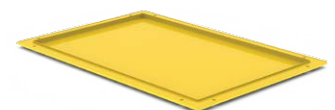

\*LID - L4060-HR

\* Lids fit trays of 10cm and 20cm high only

# DIMENSIONS

## E Type

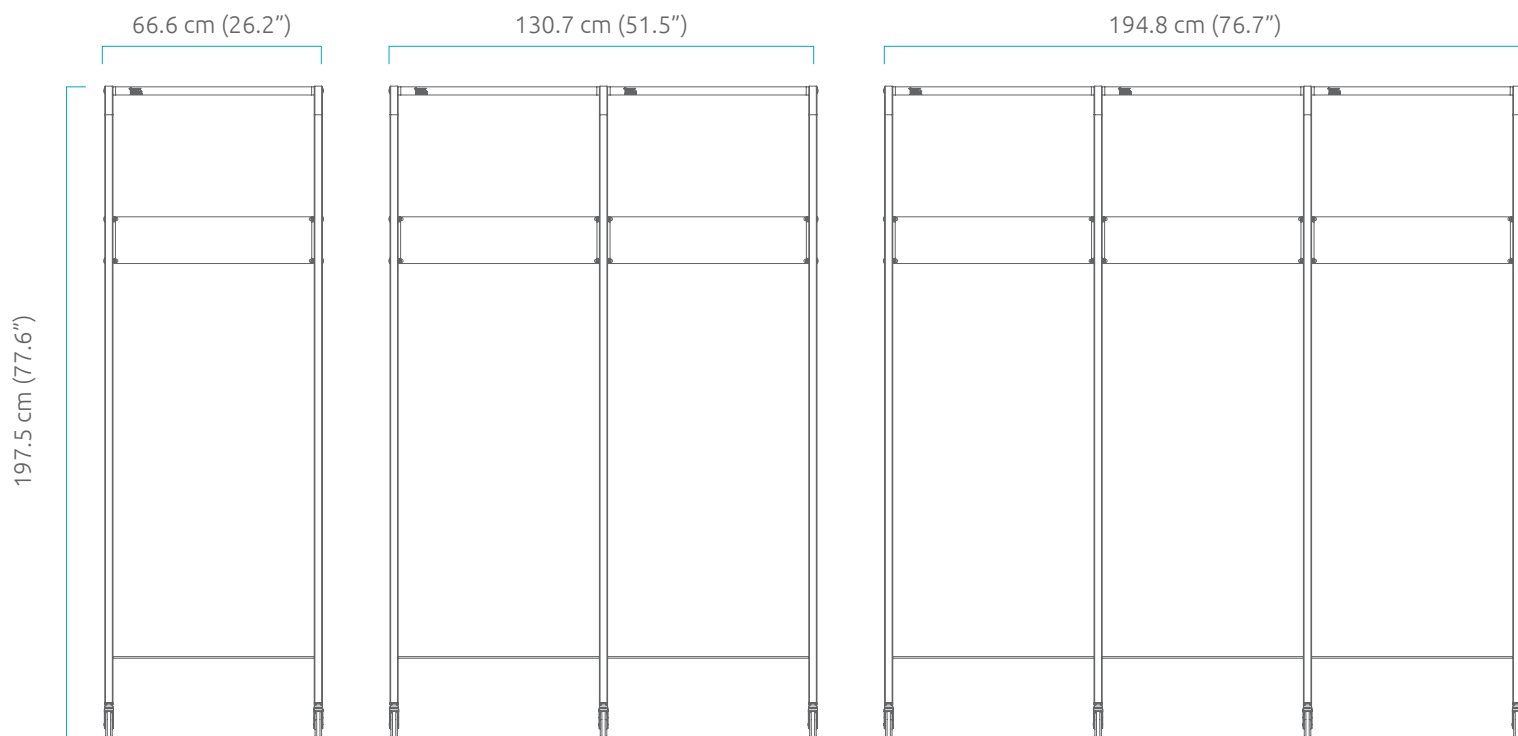

## U Type

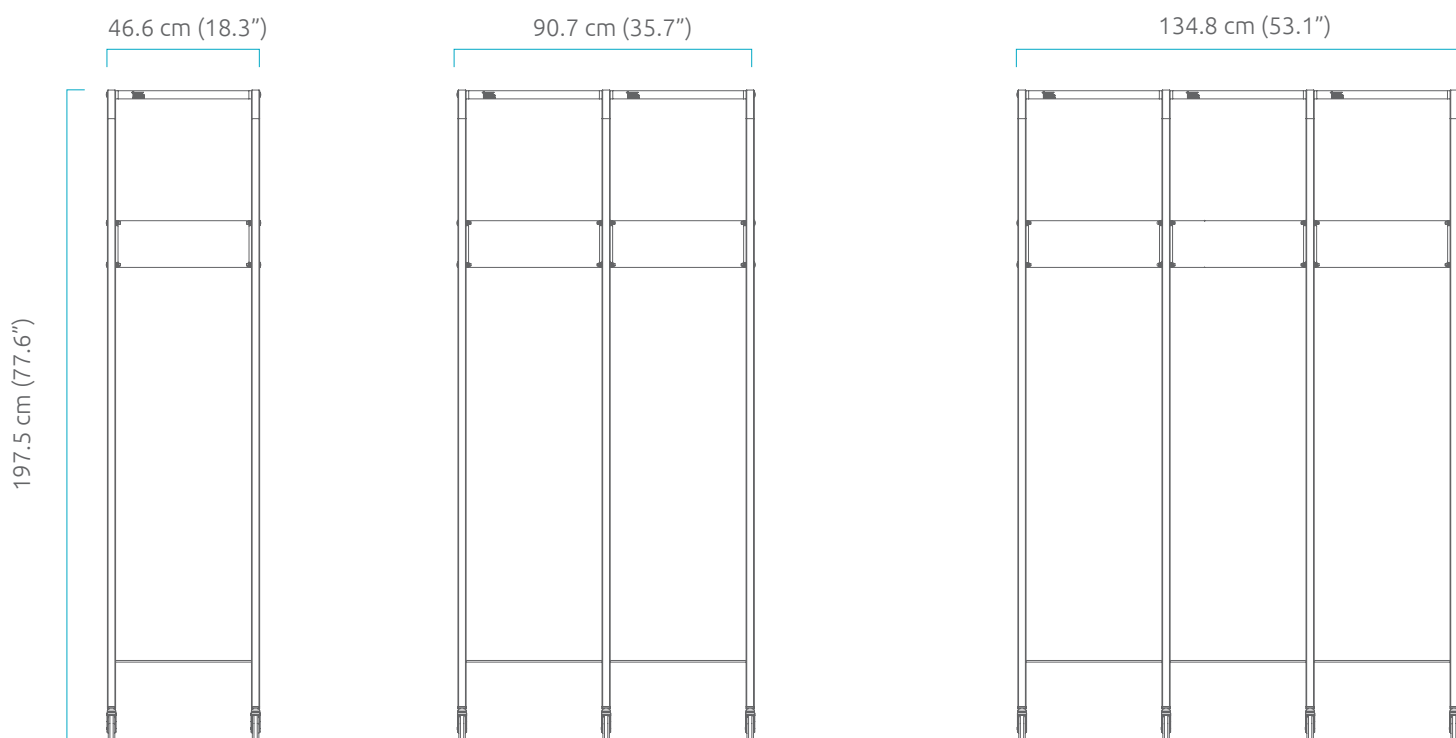

\* Also available in 210cm (82.7") height - on special order

\* Racks can be ordered with leveling feet instead of wheels – 4cm (4.6") less in height

258.9 cm (101.9")

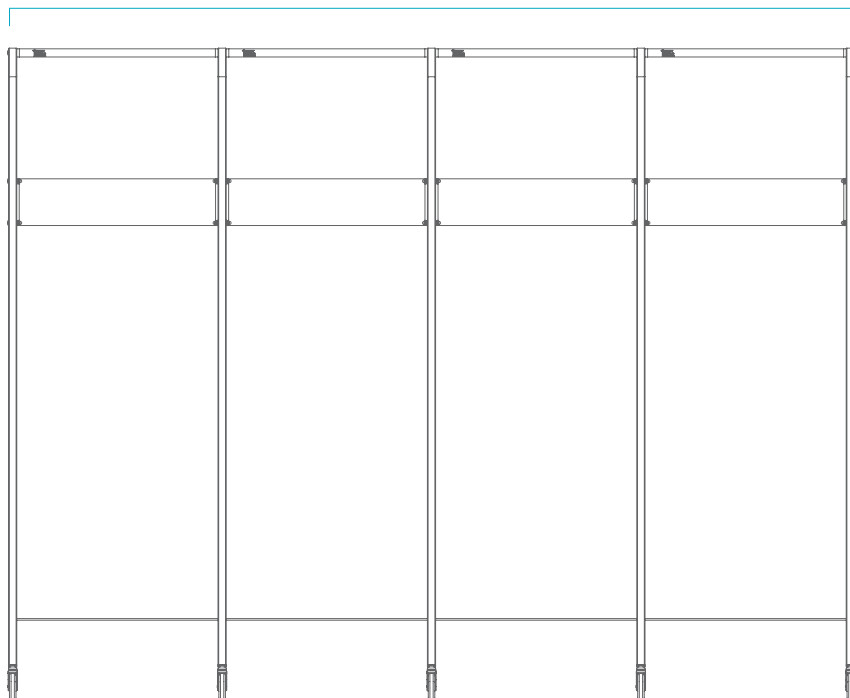

45.1 cm (17.6")

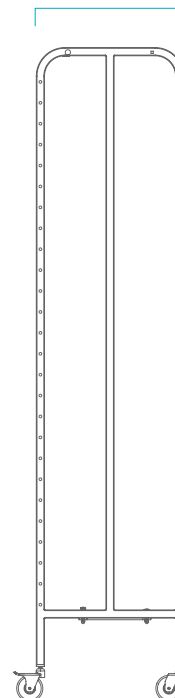

178.9 cm (70.4")

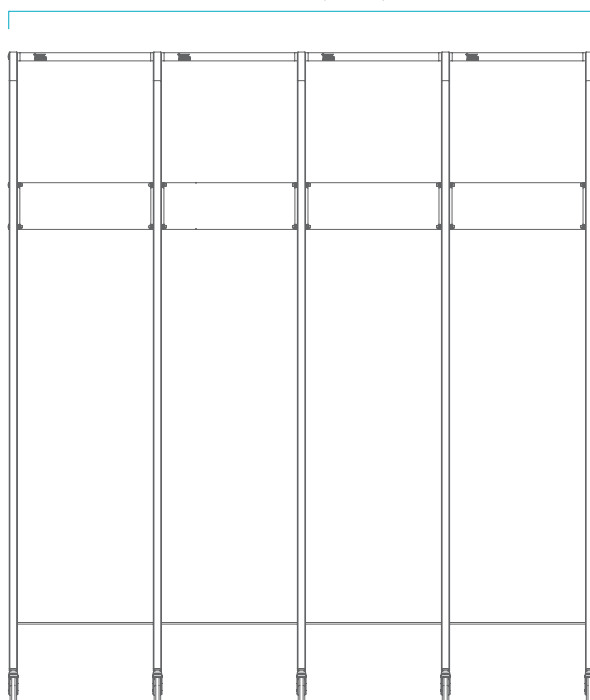

65.1 cm (25.6")

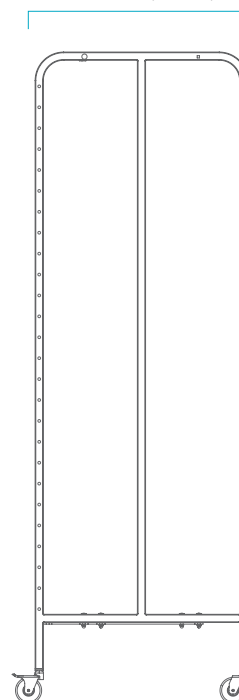

# PROJECTS

## USNS MERCY & USNS COMFORT

Our installations on the US Naval Hospital ships, Mercy and Comfort, consist of close to 1000 high-density storage racks. By using Pegasus racking system throughout the ships in locations such as the Patient Wards, OR Suites/Sterile Core and more, both vessels can deploy with enough supplies to service from 250-1000 beds with less than 48 hours notice.

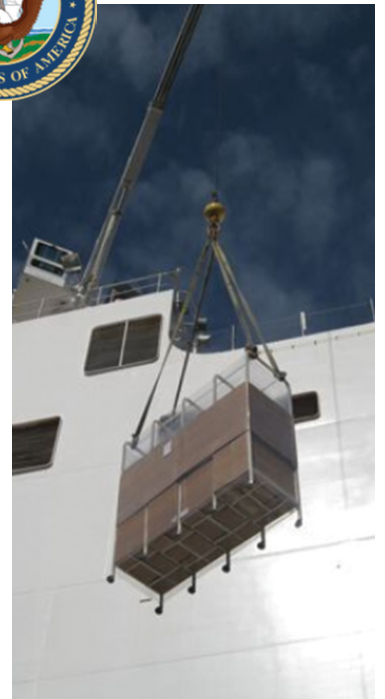

## US NAVAL HOSPITALS

Pegasus was chosen by the US Navy to design and install a Kanban inventory (2-Bin) system in combination with high-density storage racks and baskets. In doing so, Pegasus enabled 10 Naval Hospitals to reduce the amount of labor required to manage their med-surg supply levels, reduce their overall on-hand warehouse inventory, as well as increase patient care efficiencies. The US Naval Hospitals and facilities completed as of March 2017 included USNH Bremerton, WA; Charleston, SC; Corpus Christi, TX; USNH Guam, USNH Lemoore, CA; PAX River, MD; USNH Pensacola, FL; USNH Oak Harbor, WA; USNH Okinawa Japan; USNH Yokosuka, Japan.



## PENN PRESBYTERIAN MEDICAL CENTER - University of Pennsylvania

Presbyterian is the latest Pegasus Kanban project to include our new color-coded handles. The Kanban system enables the Materials Management Department to reduce its on-hand inventory levels and labor hours while improving the supply chain workflow. **This new color-coded ergonomic handle methodology adds an enhanced visual element to the system, providing both clinicians, and supply chain personnel with a quick and easy way to locate supplies.**



All supplies are categorized and assigned to a specific color grouping that is consistent throughout the facility. As Presbyterian is part of a university teaching environment, the color-coded handles allow for traveling nurses and residents to feel comfortable in the supply rooms regardless of what department they may be assigned to.

# BEFORE & AFTER

## CAPITAL HEALTH, NJ

The facility uses the Pegasus color-coding process, which allows clinicians to easily locate items based on color categories and/or by descriptions.



## VA MEDICAL CTR - LEBANON, PA

VA Lebanon deployed the Pegasus high density storage. As a result in most clean supply rooms, 40% of the floor space was recovered, allowing multiple areas to be consolidated into one storage room.



## VA MEDICAL CTR - PHILADELPHIA, PA

Usage of high-density storage in the supply distribution area created 30 % more floor space, which increased stock levels by 25%.

BEFORE



AFTER



## VA MEDICAL CTR - COATESVILLE, PA

Using Pegasus's high-density storage, 35% more storage capacity per floor was created, allowing for the storage of other necessary equipment.

BEFORE



AFTER





## CONTACT US FOR MORE DETAILS

+1 888-276-4750 | [info@pegasusmedical.net](mailto:info@pegasusmedical.net) | [www.pegasusmedical.net](http://www.pegasusmedical.net)

USA / CANADA  
905 E. Rose St Lakeland  
FL 33801 - USA

EUROPE / MIDDLE EAST / ASIA  
Damzigt 13, 3454 PS De Meern  
The Netherlands