

EcoLine

PROCEDURE &
MEDICATION CARTS



ISO 6040 MEDICAL CARTS

CONFIGURATIONS & CUSTOMIZATION

MEDICAL CARTS

Pegasus Medical provides a wide range of carts and trolleys with a variety of available accessories.

Our carts are **solid, customizable and affordable**. Their modular structure enables quick reconfiguration from a standard cart into a unique drawer configuration with designated color-coding.

Ecoline is the ideal solution for your medication and hospital supplies management needs.

Ecoline drawers are compatible with any ISO 60-40 tray/basket. And most important, the position of the drawers, trays and baskets can always be readjusted

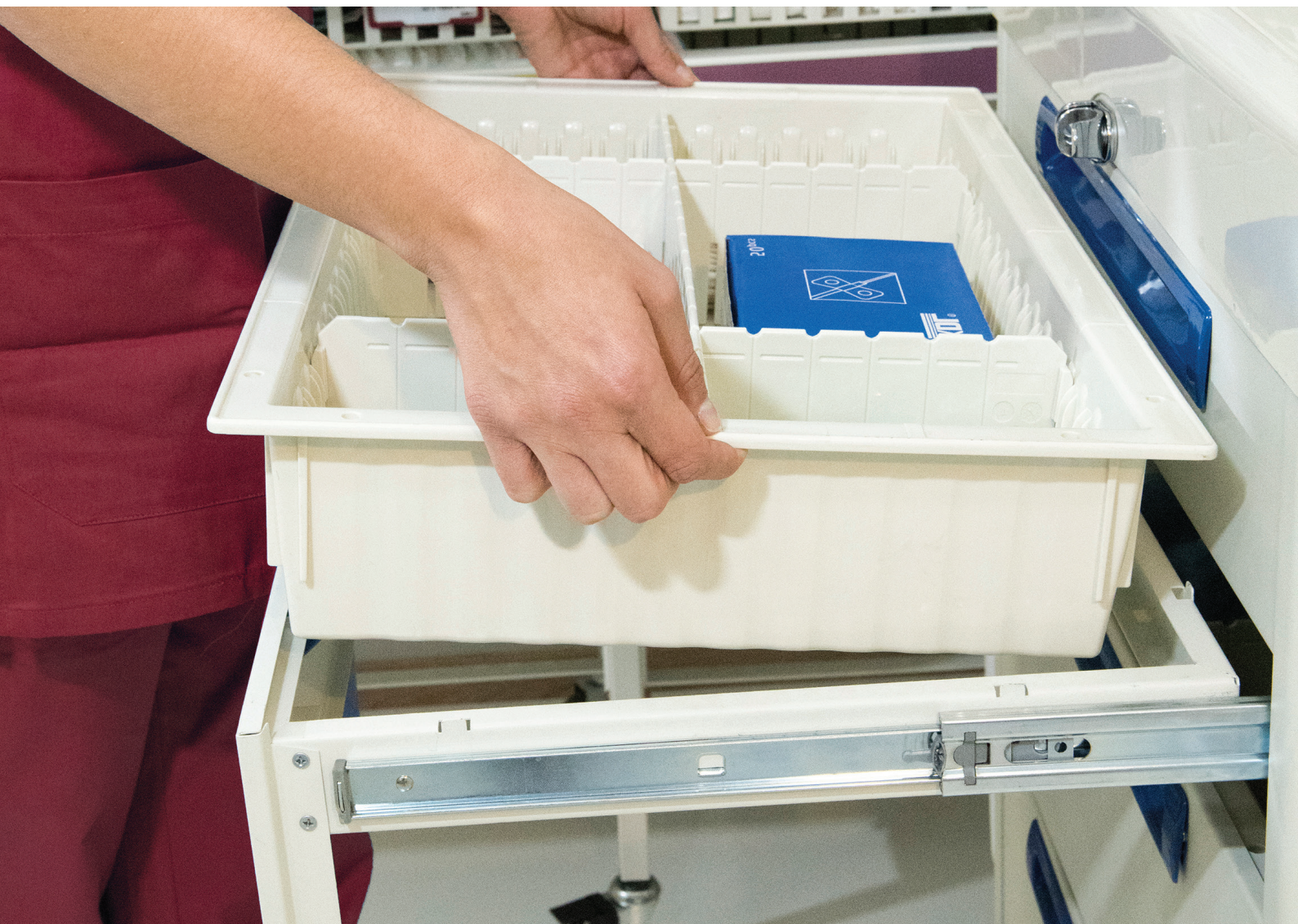

— TABLE OF CONTENTS

OPTION 1: PRE-FIXED CONFIGURATIONS

Choose a fixed configuration prepared by Pegasus personnel based on their vast experience with different types of clients in multiple markets

- 4 **PROCEDURE CARTS**
- 6 **MEDICATION CARTS**
- 8 **ISOLATION CARTS**
- 10 **ANESTHESIA CARTS**
- 12 **EMERGENCY CARTS**
- 14 **MOBILE WORKING STATION CARTS**
- 16 **SMALL FOOTPRINT CARTS**



OPTION 2: CONFIGURE YOUR OWN CART

Pick and choose your own drawer configuration and accessory line based on your target market and client demands (page 18)

- 18 **CONFIGURE YOUR OWN CART**
- 20 **ACCESSORIES FOR ECOLINE CARTS**
- 22 **3" - 6" - 9" DRAWER CONFIGURATIONS (ONLY IN USA)**
- 24 **PROJECTS - CASE STUDIES**

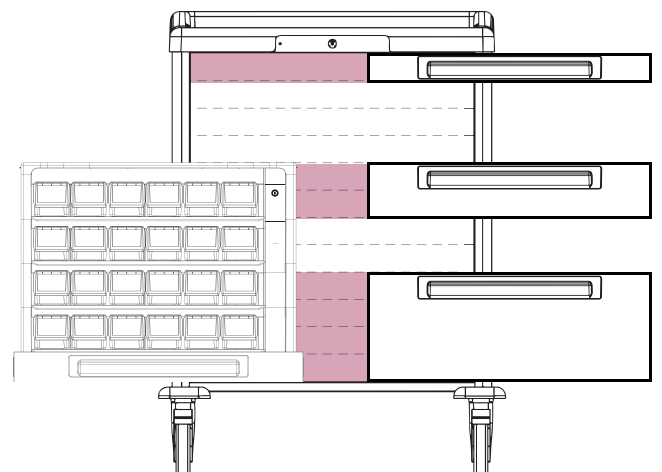

PROCEDURE CARTS

Our Procedure Cart is highly adjustable – both in terms of drawer configuration and compartment configuration. The system is completely modular in terms of bin and drawers, as well as handle colors and drawer fronts. All drawer compartments are made of ABS plastic and completely removable for stock replenishment and cleaning purposes.

PREMIUM PROCEDURE CART

The Premium Procedure cart is configured to the basic 5-drawer, fully equipped with: key lock, IV pole, worktop with side shelf to easily increase the work surface, push handle, wastebasket, Side Basket and tilt-bin holder

Accessories included in the configuration

- Worktop & side shelf
- Tilt-Bin Holder 2
- IV Pole
- Push Handle
- Side Basket
- Waste Basket



PROCEDURE CART PLUS

The Procedure cart Plus is similar to the Premium Procedure cart configuration but less accessorised. Configuration designed for more basic and less complex needs but accessories can be added on request

Accessories included in the configuration

- Standard worktop
- IV Pole
- Push Handle
- Side Basket
- Waste Basket



BASIC PROCEDURE CART

The cart is equipped with a removable standard worktop for easy cleaning, with one drawer of 20cm (8”), and 4 drawer 10cm (4”) for storage.

Accessories included in the configuration

- Standard worktop



MEDICATION CARTS

The Pegasus Medication Cart is equipped with a transferable medication cassette. This four-level cassette contains 16 to 24 bins. All bins can be locked. The cassette can be locked to the cart with the cart locking system.

The Med cassette is mounted on telescopic slides and therefore can be easily removed and replaced.

PREMIUM MEDICATION CART

The Premium Medication cart is equipped with a key lock, IV pole, worktop, push handle, wastebasket, and tilt-bin holder, and transferable four-level medication cassette. This four-level cassette contains 16 to 24 bins. All bins can be locked. The cassette can be locked to the cart with the cart locking system.

The Med cassette is mounted on telescopic slides and therefore can be easily removed and replaced

Accessories included in the configuration

- Standard worktop
- Tilt-Bin Holder 2
- Medication Cassette (4 Levels)
- IV Pole
- Push Handle
- Waste Basket



BASIC MEDICATION CART

The Default Medication cart is equipped with a worktop, 20cm (8") drawer, and a transferable medication cassette. This four-level cassette contains 16 to 24 bins. All bins can be locked. The cassette can be locked to the cart with the cart locking system.

Accessories included in the configuration

- Standard worktop
- Medication Cassette (4 Levels)



The cassettes are according to ISO standard and fit Pegasus's variety of different storage systems



ISOLATION CARTS

The Isolation Cart is traditionally marked yellow for easier identification. Yellow marking can be done instantly by adding yellow ergonomic handles, or by using a full-colored yellow drawer fronts.

ISOLATION CART PLUS

The Isolation Cart plus is traditionally marked yellow for easier identification. The cart typically has 4-5 drawers and equipped with: key lock, worktop, push handle, wastebasket, and side basket. The cart can be quickly and easily disinfected using standard protocols and disinfectants

Accessories included in the configuration

- Standard worktop
- Push Handle
- Waste Basket
- Trio Glove Holder
- Disinfection liquid bottle holder



BASIC ISOLATION CART

The Default Isolation Cart is traditionally marked yellow for easier identification. Yellow marking can be done instantly by adding yellow ergonomic handles, or by using a full-colored yellow drawer front.

Accessories included in the configuration

- Standard worktop



ANESTHESIA CARTS

Our Anesthesia Carts can be configured to the basic 5-drawer design or the super capacity 10-drawer mobile anesthesia station. Drawers can be divided easily to up to 40 compartments to meet medication storage needs.

Many accessories provided by Pegasus or 3rd-party vendors can be added if needed, including monitor arms, pumps, etc...

PREMIUM ANESTHESIA CART

The Premium Anesthesia is configured to the basic 5-drawer, fully equipped with: key lock, IV pole, worktop with side shelf to easily increase the work surface, push handle, wastebasket, and tilt-bin holder

Accessories included in the configuration

- Worktop & side shelf
- Tilt-Bin Holder 2
- IV Pole
- Push Handle
- Side Basket
- Waste Basket



PREMIUM ANESTHESIA WORKSTATION CART

The Premium Anesthesia workstation cart configured to the super capacity 10-drawer mobile working station. Drawers can be divided easily to up to 40 compartments to meet medication storage needs.

Accessories included in the configuration

- Standard worktop
- Tilt-Bin Holder 2
- IV Pole
- Push Handle
- Side Basket
- Waste Basket



EMERGENCY CARTS

The Pegasus Medical Crash Cart is easily identified by its bright-red-colored drawer fronts.

The Emergency Cart is equipped with a breakaway lock enabling 100% control of the stock stored in the cart, in between CPR procedures

PREMIUM EMERGENCY CART

The Premium Emergency Cart is easily identified by its bright-red-colored drawer fronts. The Cart is fully equipped with: Seal lock, IV pole, worktop, push handle, wastebasket, defibrillator arm, cardiac backboard, and tilt-bin holder.

Accessories included in the configuration

- Standard worktop
- IV Pole
- Push Handle
- Waste Basket
- Defibrillator Arm
- Cardiac Backboard



Back of the cart



PEDIATRIC CART

Pediatric Emergency Cart is provided with a set of color-coded ergonomic handles and a breakaway lock. The cart's drawer fronts can be red or white and the Breslow coding is provided with different colored grips

Accessories included in the configuration

- Worktop & side shelf
- Seal Lock
- Broselow Tape color-coding handles
- IV Pole
- Push Handle
- Waste Basket
- Defibrillator Arm
- Cardiac Backboard
- Oxygen Cylinder



MOBILE WORKING STATION

The Pegasus Mobile Work Station incorporates extremely high storage capacity (10 drawers) with excellent mobility. It can serve as a stationary solution in an ICU or CCU room and can be easily replaced with a clean cart when new patients arrive in the room. Such mobile solutions eliminate the need for fixed melamine or wood cabinetry that absorb moisture and create fertile ground for contamination

PREMIUM MOBILE WORKSTATION

The Pegasus medical Premium Mobile workstation incorporates extremely high storage capacity (10 drawers) with excellent mobility.

Accessories included in the configuration

- Galley top
- Tilt-Bin Holder 2
- IV Pole
- Waste Basket
- Trio Glove Holder



MOBILE WORKSTATION PLUS CART

The Pegasus Mobile Workstation Plus cart is similar to the Mobile Workstation only if a slight change in the number of accessories. Configuration designed for more basic and less complex needs but accessories can be added on request.

Accessories included in the configuration

- Galley top
- IV Pole
- Waste Basket



SMALL FOOTPRINT CARTS

The Pegasus Small Footprint Carts are designed based on the 30X40 cm modules (half ISO system). These carts are extremely light and maneuverable, and therefore a perfect fit for nurse rounds, blood specimen collection procedures and maneuvering between patients' beds.

PREMIUM SMALL FOOTPRINT CART

The Pegasus Premium Small Footprint cart designed based on the 30X40cm (12"X16") modules (half ISO system) with 5 drawers: 4X 10cm (4") drawers and 1X 20cm (8") drawer.

Accessories included in the configuration

- Worktop & side shelf
- Tilt-Bin Holder 2
- IV Pole
- Push Handle
- Side Basket
- Waste Basket



SMALL FOOTPRINT PLUS CART

The Pegasus Small Footprint Plus cart is similar to the Premium Small Footprint cart only if a slight change in the number of accessories. Configuration designed for more basic and less complex needs but accessories can be added on request

Accessories included in the configuration

- Standard worktop
- IV Pole
- Push Handle
- Side Basket
- Waste Basket



SELECT A CART TYPE

SELECT A CART TYPE



CRT-M31

L77cm | D56cm | H79cm
L30.5" | D22" | H31"

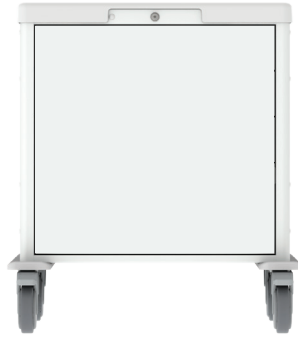

CRT-M35

L77cm | D56cm | H89cm
L30.5" | D22" | H35"

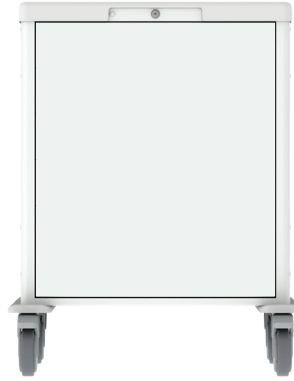

CRT-M39

L77cm | D56cm | H99cm
L30.5" | D22" | H39"

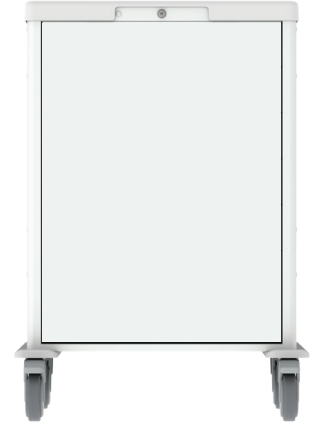

CRT-M43

L77cm | D56cm | H109cm
L30.5" | D22" | H43"

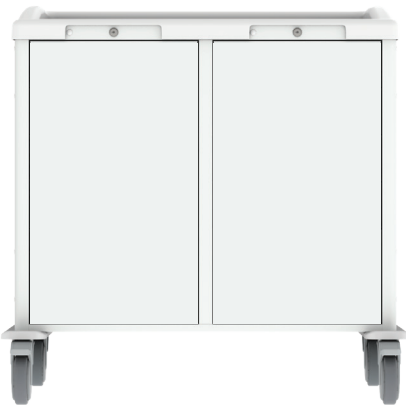

CRT-MUU39

L104cm | D75.5cm | H104cm
L41" | D30" | H41"



CRT-NM35

L47cm | D55.5cm | H88.5cm
L18.5" | D22" | H33.7cm



CRT-NM39

L47cm | D55.5cm | H100.5cm
L18.5" | D22" | H39.6"



CRT-NM43

L47cm | D55.5cm | H112.5cm
L18.5" | D22" | H44.3"

CHOOSE TOP

Ecoline carts offer you a choice of 3 different worktops:

A Standard worktop **B** 3-sided galler top and **C** galler top side shelf. The overall final height of your Ecoline cart depends on the worktop you choose as follows:

	HEIGHT OF YOUR CART WITH:	CRT-M31KL	CRT-M35KL	CRT-M39KL	CRT-M43KL
A	STANDARD WORKTOP #CRTA-TOPPC-ST	79cm (31")	89cm (35")	99cm (39")	109cm (43")
B	WORKTOP GALLERY TOP #CRTA-TOPPC-3SGT	84cm (33")	94cm (37")	104cm (41")	114cm (45")
C	3 SIDED GALLERY & SIDE SHELF #CRTA-SLSHLF-R	89cm (35")	99cm (39")	109cm (43")	119cm (47")

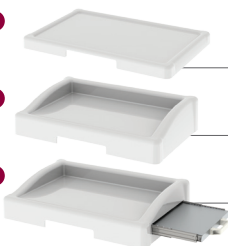

Tops for Small Footprint cart



DEFAULT

Or



CRTA-NM-SLSHLF-R

Top for workstation



DEFAULT

CHOOSE DRAWERS

CHOOSE DRAWERS

Ecoline carts - drawer front configurations

Ecoline offers a choice of 3 drawer heights. Each of these heights will use a number of space units. A single space unit reaches the height of a 2" drawer (5 cm)

12 SPACE UNITS

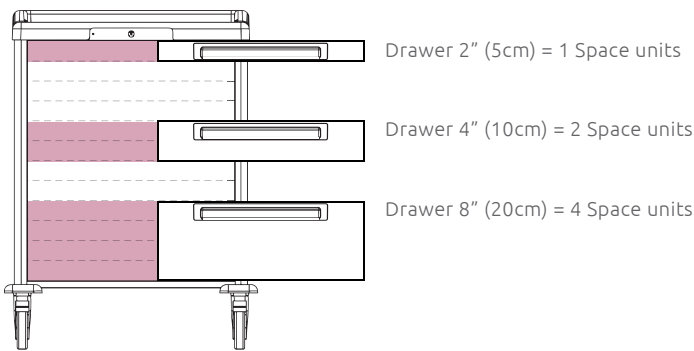

12 SPACE UNITS

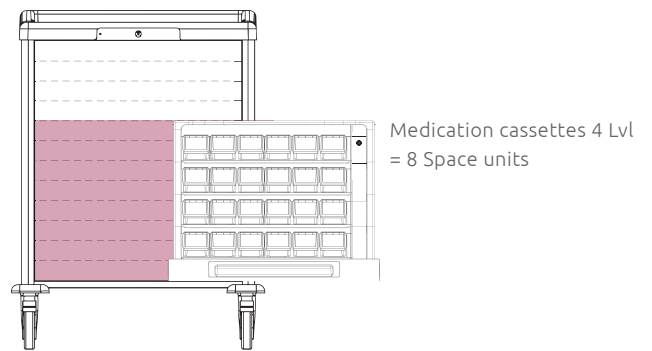

Select the desired height of your carts. Ecoline offers 4 standard cart heights, each with a specific number of available space units:

8 SPACE UNITS

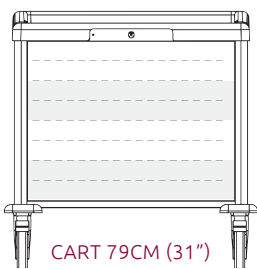

CART 79CM (31")
HAVE 8 SPACE UNITS

10 SPACE UNITS

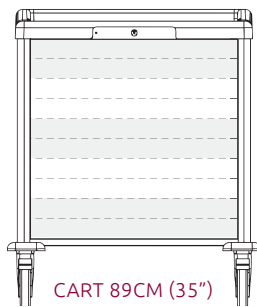

CART 89CM (35")
HAVE 10 SPACE UNITS

12 SPACE UNITS

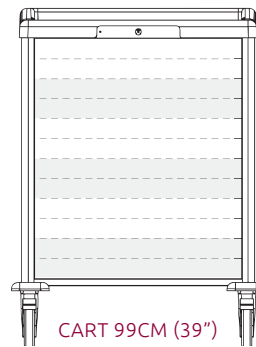

CART 99CM (39")
HAVE 12 SPACE UNITS

14 SPACE UNITS

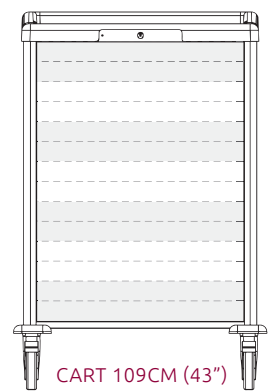

CART 109CM (43")
HAVE 14 SPACE UNITS

Select the drawer heights that suit your needs. Start from the top with the 2" (5 cm) drawer, followed by the 4" (10 cm) drawer and 8" (20 cm) drawer. Taller drawers are always at the bottom. Make sure that the sum of the space units of your drawers is equal to the specific number of available space units in your cart.

CHOOSE KIT COLOR HANDLES

All the handles come in a pack of 90 units (except for Paediatric set)



Teal



Dark Blue



Ruby



Beige



Light gray



Lavender

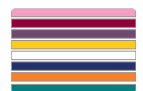

Paediatric set

For E type

CRTA-MKHND-TE

CRTA-MKHND-DB

CRTA-MKHND-RU

CRTA-NMHND-BE

CRTA-MKHND-LG

CRTA-MKHND-LAV

CRTA-MKHND-BRS-SET

For UU & U type

CRTA-NMHND-TE

CRTA-NMHND-BE

CRTA-NMHND-LG

CRTA-NMHND-LAV

(Default - RAL 7035)

ACCESSORIES

LOCKS

RFID ELECTRONIC LOCKS

#item number
RFID Electronic lock with four-digit user code



COMBINATION LOCK

#CRTA-MK39/43ELKIT
Electronic lock with four-digit user code



KEY LOCK

Provided as a standard



SEAL LOCK

#CRTA-BRO-LOCK
Breakaway/seal lock



ACCESSORIES

ALUMINUM ACCESSORY RAIL

#CRTA-SRAIL-MK/NM
For mounting various accessories on carts



ERGONOMICS

PUSH HANDLE

#CRTA-ALPH-MK/NM
Aluminum 40cm (16")



ALUMINUM ACCESSORY RAIL MUU

#CRTA-SRAIL-MUU39
For mounting various accessories on MUU carts



PUSH HANDLE

#CRTA-ALPH-MUU39
Aluminum 60cm (24")



DIN RAIL HOOKS

DIN-HKS-GBH-SET
A set of 2 DIN rail hanging hooks for glove box holder & bottle holder



WASTE BASKET

#CRTA-WSBIN
Waste basket, large - 10L with holder 26x20x36.5cm (10.4x8x14.6")



DISINFECTION LIQUID BOTTLE HOLDER

#DLBH-PP +
#DIN-HKS-GBH-SET
Simple, hidden, click to open mechanism
Max: 7cm bottle diameter



SIDE CATHETER BOX*

#CRTA-CATH-HLD
10.2x10.2x45cm (4x4x18")
Steel boxes with flexiglass panel



GLOVE HOLDER

#S-GBH-ABS +
#DIN-HKS-GBH-SET
For holding a disposable
Maximum box size:
14.5X24.5X8cm



SIDE BASKET

#CRTA-SBASKET
Wire side basket
44x16x19cm
(17.6x6.4x7.6")



TRIO GLOVE HOLDER

#TR-GBH-ABS +
#DIN-HKS-GBH-SET
For holding 3 disposable
Maximum box size:
14.5X24.5X8cm



Require two accessory rails

MORE STORAGE

TILT-BIN HOLDER 2

#CRTA-TBH-2
Tilt-Bin holder for 2 rows
Height above cart:
62.1cm (24.8")



TILT-BIN HOLDER 3 **

#CRTA-TRL-3
Tilt-Bin holder for 3 rows
Height above cart: 86cm
(34.4")



TILT BIN 4

#TILTBIN-4
60 cm wide

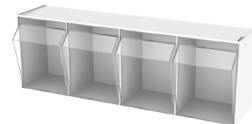

TILT BIN 5

#TILTBIN-5
60 cm wide

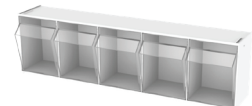

TILT BIN 6

#TILTBIN-6
60 cm wide

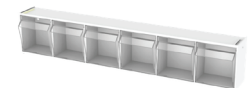

TILT BIN 3

(for small footprint
cart)
FLEX-BIN-DL
30 cm wide

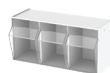

FOLDABLE FRAME

#CRTA-SFRAME-FL



For side shelf #SHELF-HPL3040
For side tray #T103040
For side small tray #T053040
For side Basket #B103040



EMERGENCY

IV POLE

CRTA-IVPOLE-HA
Height adjustable IV pole
Max height 188cm (74")



CARDIAC BACKBOARD

#CRTA-CARBACKB
With hanging hooks
Acrylic 51x44cm
(20.4x17.6")



DEFIBRILLATOR ARM

#CRTA-SDIFARM
Swiveling defibrillator arm
powder-coated steel



OXYGEN CYLINDER

#CRTA-OXBH1
Side oxygen cylinder
PVC-coated steel wire

Require two accessory rails



HAZARD BIN HOLDER

#CRTA-HAZB-HL
Powder-coated steel



DISPOSABLE SEAL

#PSSEAL-R
Disposable Seal, 100
PCS per pack



3" - 6" - 9" DRAWER CONFIGURATIONS

Our Ecoline cart is also available in US Drawer Sizes of 3", 6" & 9" Deep

(Available for N.A. customers only)



Ecoline Carts - US Draw Front Configurations

US standart Ecoline offers a choice of 3 drawer heights. Each of these heights will use a number of **space units**. A single space unit corresponds to the height of a 3" drawer. Please look at the schematics below:

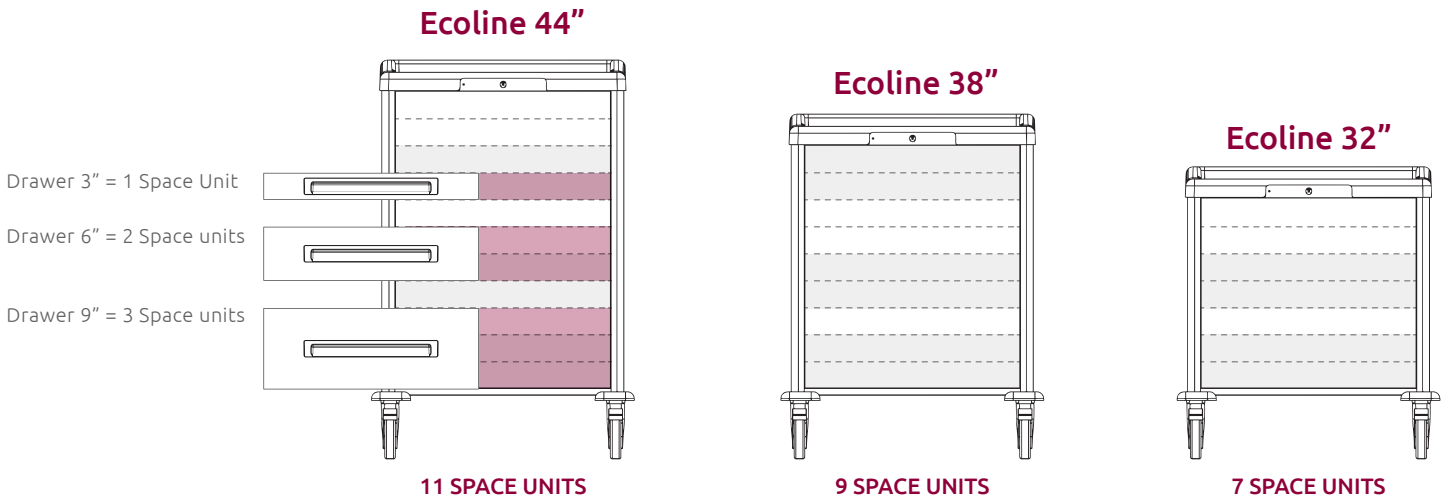

Ecoline 44" Height Configurations

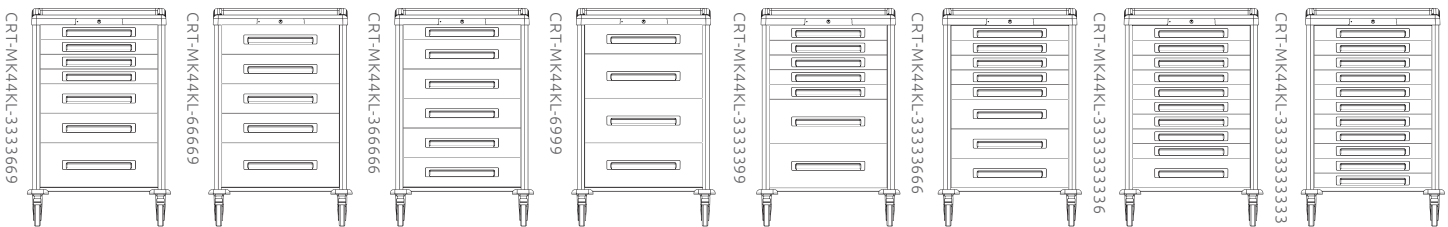

Ecoline 38" Height Configurations

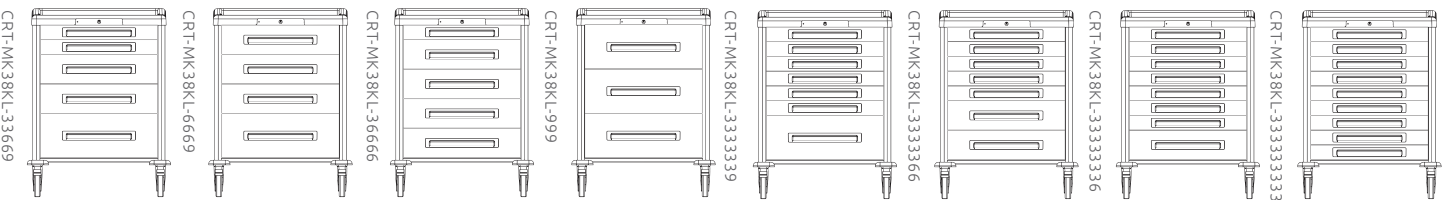

Ecoline 32" Height Configurations

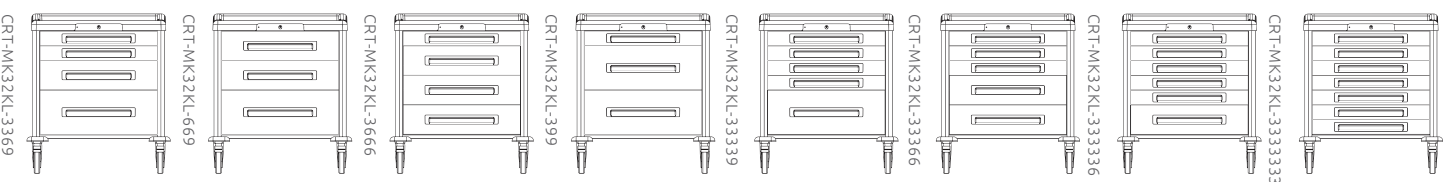

Erasmus MC hospital in the Netherlands

Approximately 400 Ecoline carts in total were developed tailor-made for all the specific departments within the Erasmus MC. Users of the different departments were given forms in which they could fully configure their own carts to their wishes, like cart lay-out and accessories

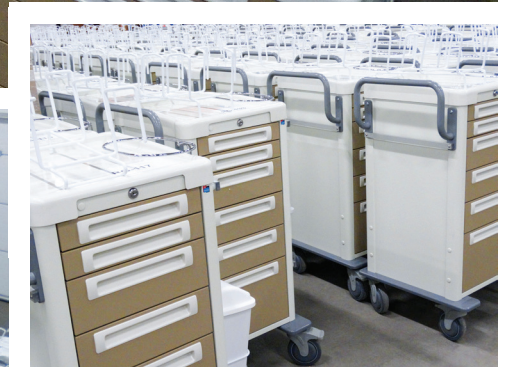

Ecoline mobile casting working station

A Dedicated silver color Ecoline working station was customized with stainless steel working surface and side ss container, to be used as a mobile casting working station.



Ecoline sedation cart

Customized installation of Ecoline cart in OR surroundings, including dedicated computer arms and multiple electricity sockets.



Ecoline all in one cart

A large installation of Ecoline medication distribution carts with dedicated Vesa arm, computer, power supply kit and RFID lock

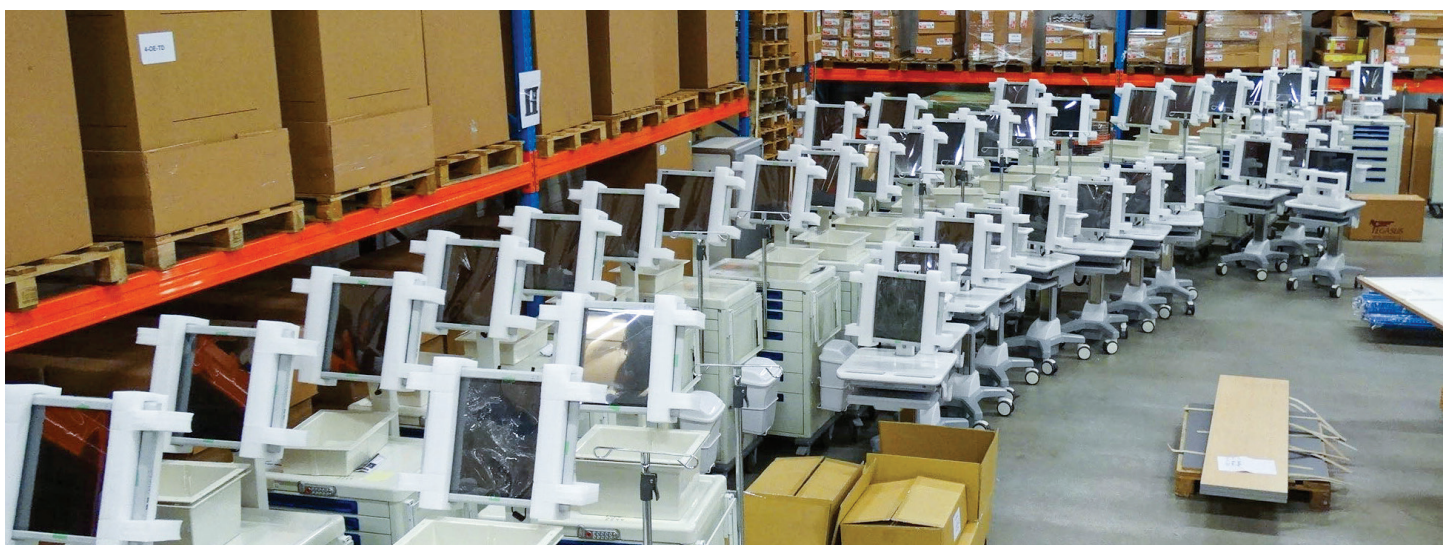



CONTACT US FOR MORE DETAILS

+1 888-276-4750 | info@pegasusmedical.net | www.pegasusmedical.net

AMERICAS / CANADA / MEXICO / CARIBBEAN
905 E. Rose St
Lakeland FL 33801 - USA

EUROPE / MIDDLE EAST / ASIA
Damzigt 13, 3454 PS De Meern
The Netherlands